

Part number

# CMEF 03 T

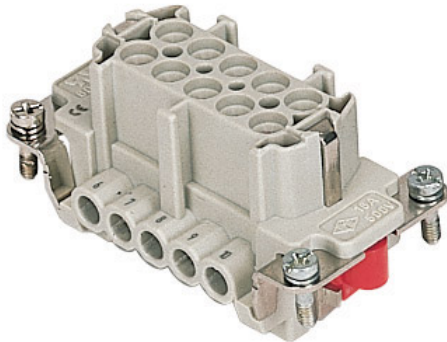

## Brief description:

female insert, 3 poles + PE, screw terminal connections, 16A, 830V, (2 poles (16A, max - 500V/6kV/3 , 8kV, 3, silver plated, size "57.27" insulated 830V, CLASS insert series

### Product description

<b>Model</b>	female insert
<b>Version</b>	screw terminal connections
<b>Series</b>	CME
<b>Product type</b>	with female contacts
<b>Variant</b>	with plate
<b>Family</b>	CLASS inserts
<b>Size</b>	size "57.27" insulated 830V
<b>N. of poles</b>	3 poles + 
<b>Auxiliary poles</b>	2 poles (16A max - 500V/6kV/3)



### Technical data

<b>Current</b>	16 A
<b>Voltage</b>	830 V
<b>Rated impulse withstand voltage</b>	8kV
<b>Pollution degree</b>	3
<b>Wire cross-section</b>	0,50 mm <sup>2</sup> - 4,00 mm <sup>2</sup>
<b>AWG size</b>	20 - 12
<b>Operating temperature range (min, max)</b>	-40°C ... +125°C
<b>Contact type</b>	silver plated
<b>Mating cycles</b>	≥ 500
<b>IP degree of protection</b>	IP20 without enclosure, IP65/IP66 with enclosure
<b>PE wire cross-section</b>	0,14 - 4 mm <sup>2</sup> ; AWG 20 - 12

### Further technical details

<b>Characteristics according to EN 61984</b>	16A 830V 8kV 3 (aux: 16A 500V 6kV 3); 16A 1000V 8kV 2 (power contacts only)
<b>Insulation resistance</b>	≥ 10 GΩ
<b>Rated voltage according to UL/CSA</b>	600V
<b>UL 94 flammability rating</b>	V-0
<b>Weight</b>	67,00 g

### Approvals / Standards

<b>Reference standard</b>	EN 61984 (2001-11)
<b>Quality mark</b>	   , EAC
<b>Conformity</b>	CQC, CE

### General ordering information

<b>EAN13 code</b>	8015747127899
<b>Tariff number</b>	85369095
<b>Country of origin</b>	Made in EU (IT)
<b>ETIM classification</b>	EC000438

### Packaging Information

<b>Packaging length</b>	210,00 mm
<b>Packaging height</b>	130,00 mm
<b>Packaging width</b>	240,00 mm
<b>Packaging weight</b>	2,00 kg
<b>Packaging volume</b>	6,55 dm <sup>3</sup>
<b>Packaging description</b>	Carton box
<b>Packaging quantity</b>	30 Pcs
<b>Packaging EAN code</b>	8015747128025
<b>Sub-packaging weight</b>	0,33 kg
<b>Sub-packaging description</b>	Carton
<b>Sub-packaging quantity</b>	5 Pcs
<b>Sub-packaging EAN barcode</b>	8015747128018

Part number

# CMEF 03 T



## Catalogue drawings

### CMEM 03

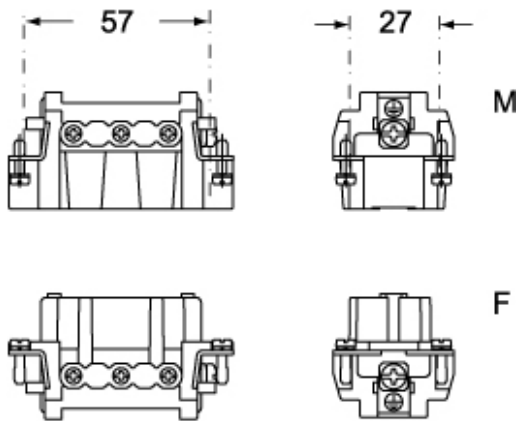

### CMEF 03

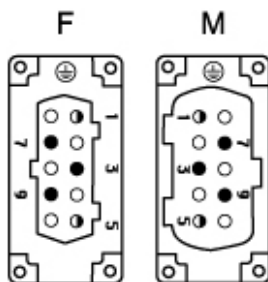

## Catalogue drawings

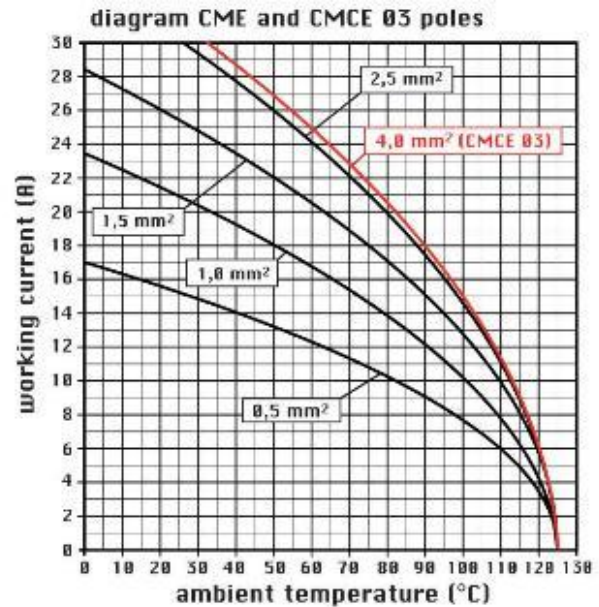

## Notes

### CMEF/M 03 T inserts

- characteristics according to EN 61984:
- 16A 830V 8kV 3
- 16A 1000V 8kV 2
- 16A 720/1250V 8kV 2
- auxiliary contacts: 16A 500V 6kV 3
- UL, CSA, CCC, GOST certified
- rated voltage according to UL/CSA: 600V
- insulation resistance: > 10 GOhm
- ambient temperature limit: -40 °C ... +125 °C
- are made of self-extinguishing thermoplastic resin UL 94 V0
- mechanical life: > 500 cycles
- contact resistance: < 1 mOhm
- enclosures: size 57.27
- insulated 830V
- T-TYPE IP65 insulating
- W-TYPE aggressive environments
- IP68

- CME....: for non-prepared conductors
- inserts with plate, for section conductors:
- 0.5 - 4 mm<sup>2</sup> - AWG 20 - 12
- conductors stripping length: 7 mm
- terminal screw torque: 0.5 Nm

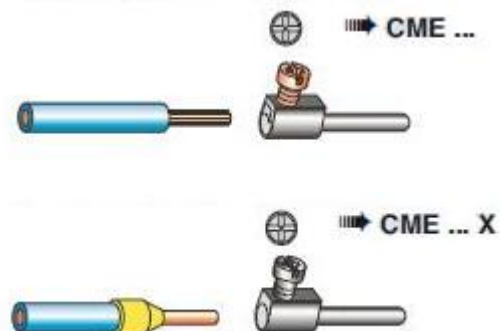

- CME .....X: or bush terminal conductors
- inserts without plate, for section conductors:
- 0.25 - 2.5 mm<sup>2</sup> - AWG 24 - 14

- conductors stripping length: 7 mm
  - terminal screw torque: 0.5 Nm
-